

February 21, 2018

Dr. Andrew Rawicz
School of Engineering Science
Simon Fraser University
8888 University Dr
Burnaby, BC
V5A 1S6

RE: ENSC405W Requirement Specifications. - Ripple Reader: The Affordable Braille Reader of Tomorrow

Dear Dr. Rawicz,

Please find our requirements documentation for the Ripple Reader, enclosed within. Our mission, at LampLight Labs, is to develop a text to braille reader that is affordable, user friendly, and can be accessed by a wider population than traditional devices. We plan to combine the latest in optical character recognition technology, powerful microprocessors, and cutting-edge hardware design to accomplish our goals. The Ripple Reader takes an innovative spin that is guaranteed to make a splash in the technology industry.

This document will start with an introduction of our product and our initial target market; followed by a brief systems overview of the Ripple Reader; then an indepth exploration of critical requirements and subsequently the standards we shall adhere to. Futhermore, an explanation of the product's lifecycle and sustainability will be addressed. Finally, we will justify our reasoning for our requirements

LampLight Labs consists of five passionate and motivated individuals including Caelan Midwood, Connor Heidema, Randeep Shahi, Amir Hadjifaradji and Abiman Mahendra. Should you have any questions or concerns feel free to contact our COO Connor Heidema at any time. You can reach him at 604-868-9195 or by email at cheidema@sfu.ca.

Best Regards,

Caelan Midwood
Chief Executive Officer
LampLight Labs

Enclosure: Requirements for the Ripple Reader



LampLight Labs



Team: Caelan Midwood

Connor Heidema

Randeep Shahi

Abiman Mahendra

Amir Hadjifaradji

Contact: Connor Heidema

cheidema@sfu.ca

604-868-9195

Submitted to: Dr. Andrew Rawicz

Prof. Steve Whitmore

School of Engineering Science

Simon Fraser University

Issued On: February 21st

Abstract

Over the past few decades, numerous technological advances have made access to digital, or digitally scanned sources, nearly universal. The most famous of these, besides the advent of the personal computer (PC), was the smart device revolution that kicked off in the early 2000's with Apple's iPhone. A primary function of these smart devices included giving the user the ability to read digital documents even when they were not at home. Unfortunately, while many engineers have tried building such devices for the visually impaired, it was vastly more difficult, and thus, the technology in this field progressed at a far slower rate. This gave the visually impaired a disadvantage in today's schools when it came to learning.

As such, the purpose of this paper is to outline the requirements for a cutting-edge braille reader called the Ripple Reader. Our implementation of the braille reader will significantly reduce the price of the product by both offboarding several components of the software to a mobile phone along with using a unique electro-mechanical multiplexing system to control the refreshable braille cells. The Ripple Reader will provide USB input along with support for both optical character recognition (OCR) to give the user more access to tactile information alongside a user configurable audio feedback to give the user an opportunity to have near-instant spoken feedback for the character or word they just read.

Via our safe, sustainable, and affordable device, LampLight Labs aims to minimize the technological gap the visually impaired face in hopes to subsequently lessen the divide in employment and education present today for the demographic.

Table of Contents

Abstract.....	ii
Figures	iv
Tables	iv
1. Introduction	1
1.1 Scope	1
1.2 Intended Audience.....	1
2. System Overview	2
2.1 Main Overview	2
2.1.1 Actuation State	3
2.1.2 Data Capture State.....	3
2.1.3 Audio Feedback State	4
2.1.4 Scroll State	4
3 Requirement Conventions.....	5
3.1 Configurations.....	5
3.2 Classification.....	5
4. Requirements.....	6
4.1 Functional Requirements	6
4.2 General Requirements.....	7
4.3 Software Requirements	8
4.4 Hardware Requirements.....	9
4.5 Mechanical Requirements	10
4.6 Electrical Requirements.....	10
4.7 Sustainability Requirements	11
4.8 Safety Requirements	12
5. Related Engineering Standards and Guidelines.....	13
5.1 Braille.....	13
5.2 Broadcasted Signals & Data Types	13
5.3 Printed Circuit Board & Electronics.....	14
5.4 Software.....	14
5.5 Other.....	14
6. Cradle to Cradle Lifecycle	15
6.1 Selecting Materials	16
6.2 Recycling and Reusing Materials.....	16
6.3 Reducing Materials	16
6.4 Disposing Materials	16
7. Conclusion	17
References.....	18
Appendix I	20

Figures

Figure 1 State diagram for the Ripple Reader	2
Figure 2 Activity diagram of Actuation state	3
Figure 3 Activity diagram of Data Capture state	3
Figure 4 Activity diagram of Audio Feedback state.....	4
Figure 5 Activity diagram of Scroll state	4
Figure 6 Naming conventions for board configurations.....	5
Figure 7 Model of the Ripple Readers Lifecycle	15
Figure 8 Proof of Concept Ripple Reader.....	20

Tables

Table 1 Section numbers pertaining to requirements	5
Table 2 Configurations listed for each requirement	5
Table 3 Functional Requirements.....	7
Table 4 General Requirements	8
Table 5 Software Requirements.....	9
Table 6 Hardware Requirements	9
Table 7 Mechanical Requirements.....	10
Table 8 Electrical Requirements	11
Table 9 Sustainability Requirements	12
Table 10 Safety Requirements.....	12
Table 11 Braile Standards.....	13
Table 12 Broadcasted Signals & Data Types	13
Table 13 PCB & Electronics	14
Table 14 Software Standards.....	14
Table 15 Other Standards.....	14
Table 16 POC Requirements	20

1. Introduction

In the 1960's, over 50% of students who were blind were also literate in Braille [1]; however, since 1963 there has been a sharp decline in braille literacy [2]. Today, literacy rates among students who are visually impaired has gone down to approximately 10% [3], [1], "50% of students who are blind dropout before graduating High School, 70% of blind adults are also unemployed and 75% of individuals who are illiterate are on government assistance" [1]. In contrast according to UNESCO more than 91% of people throughout the world can read as of 2016 and these statistics are steadily increasing [4].

At LampLight Labs, we are ambitiously researching ways to rectify these statistics by advancing technology giving everyone an equal opportunity to learn. Our solution is the Ripple Reader, an affordable braille reader with audio feedback which can take an image or video feed as an input and transform it to braille for users to read.

Our device builds upon current devices. As such, it is important that our functional requirements preserve key features. While keeping this in mind, we also put a large emphasis on user factors included in the device ensuring that the device is safe and simple to use. Further, we considered making our device sustainable using methods of biocompatibility of components and scale of recyclability of materials to reduce the devices ecological footprint.

1.1 Scope

The following document is meant to elaborate on the Ripple Reader and highlight the requirements, and standards we will comply to, providing a device which is both safe and effective in its intended use. The requirements highlight the many environments our device will be in along with a cradle to cradle lifecycle of the device. Requirements have been classified in terms of our 3 stages of development: Proof-of-Concept (POC), Prototype (PRT) and Production (PRD).

1.2 Intended Audience

The document is primarily intended to be used by the electrical, mechanical and software engineers at LampLight Labs during the design and verification stages and for any stake holders involved in the project. Requirements are a means of designing for user needs. Because of this, our engineers are expected to research and follow these requirements during design. These requirements will be designed to be testable on a pass/fail basis to assure the end user gets the product they asked for.

A second audience of this document is the purchaser of the product to have a clear understanding of what they are buying as both a sum of parts and a whole. This document outlines everything the user should expect from components of the project and can be used as a secondary reference to the user manual later to understand how to effectively handle the product when they are finished with it.

2. System Overview

As we are designing a complex product, it is important to separate functional components into separate states, as shown in *Figure 1* to more deeply understand this device's high level functional requirements. The first of these states is the Off state, where data is stored while the Ripple Reader does no other electrical work to conserve battery power. The next state, the actuation state, is where mechanical rods are moved up and down to ensure the user may read braille when they move their fingers along the array. The third state, the data capture state, is where data can be collected via camera or USB for the device to acquire new content. The fourth state, the audio feedback state is where the user indicates, by pausing at the position, they do not understand the word they are reading. The Ripple Reader attempts to read what the user cannot with auditory feedback, to help the user further understand braille. Finally, the scroll stage is where the user may press the next or previous buttons to refresh the reader with a new set of character, so the user can read through an entire document.

Figure 2, Figure 3, Figure 4, and Figure 5 over the following pages, illustrate the 4 active states in more detail.

2.1 Main Overview

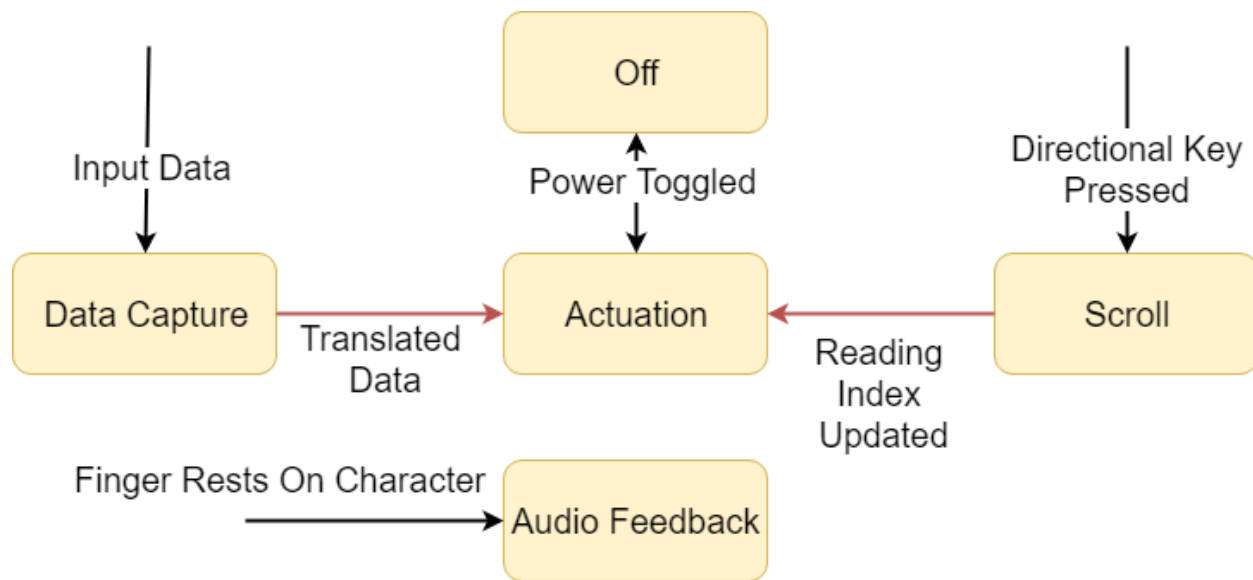

Figure 1 State diagram for the Ripple Reader

2.1.1 Actuation State

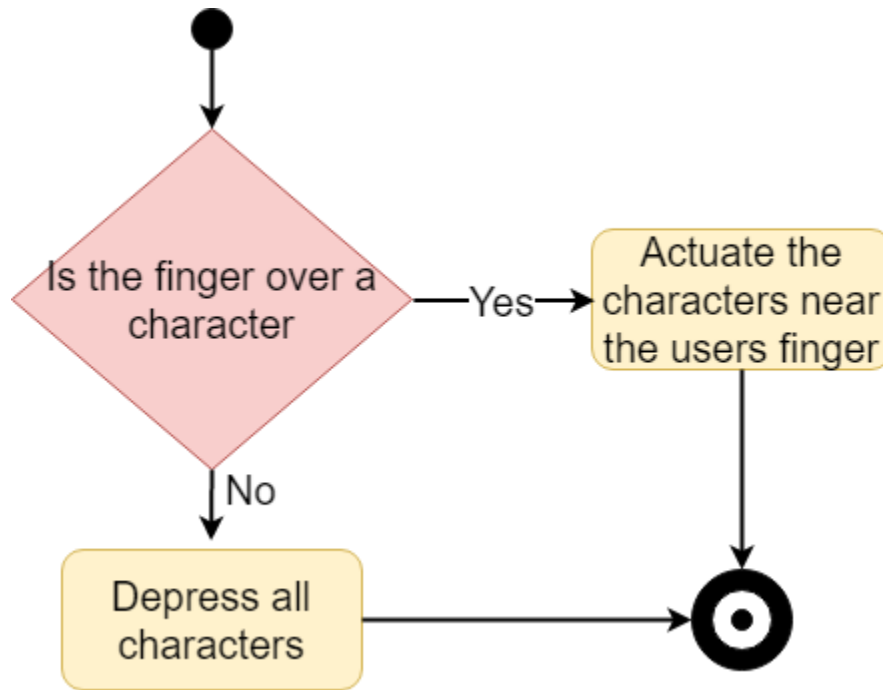

Figure 2 Activity diagram of Actuation state

2.1.2 Data Capture State

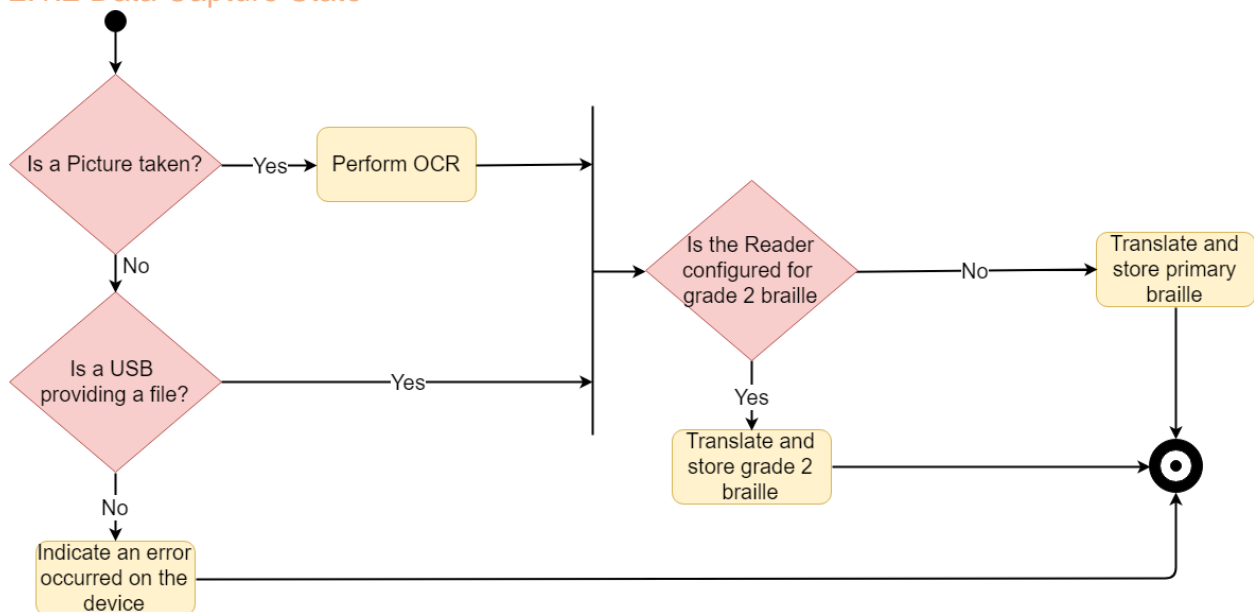

Figure 3 Activity diagram of Data Capture state

2.1.3 Audio Feedback State

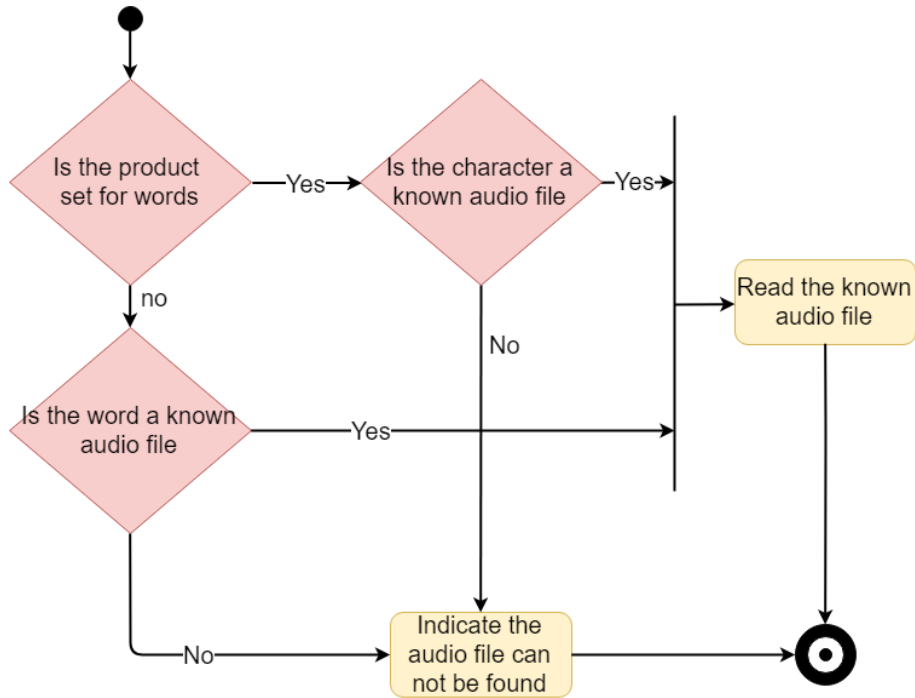

Figure 4 Activity diagram of Audio Feedback state

2.1.4 Scroll State

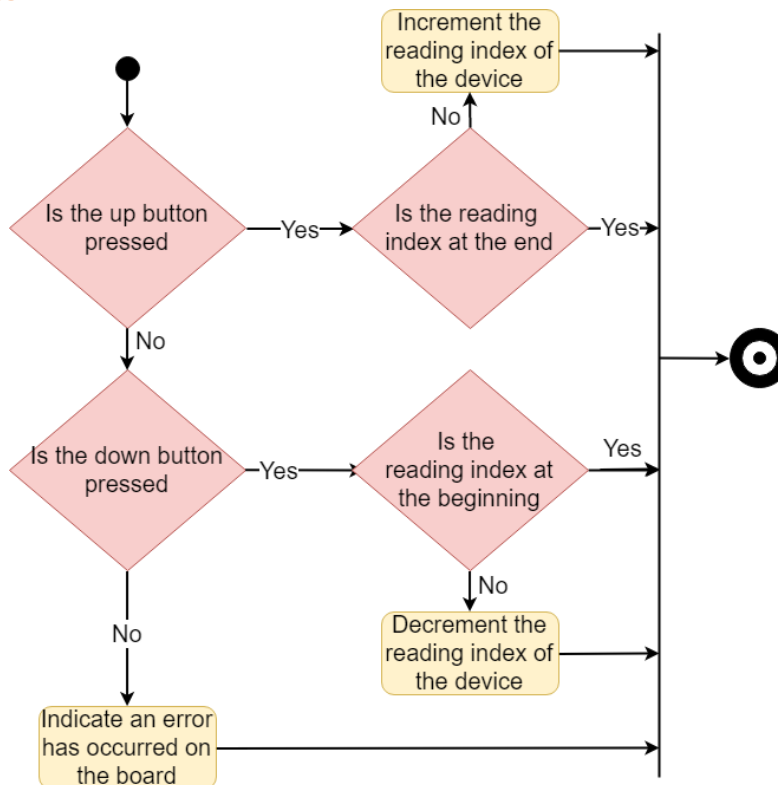

Figure 5 Activity diagram of Scroll state

3 Requirement Conventions

3.1 Configurations

Due to the nature of our diverse market, there is both a modular onboard and offboard configuration. The Ripple Reader can be broken up into the “master” and the “slave” portion. For the sake of this document the master portion will pertain to the part of the system that captures the picture, performs OCR on it, converts the text to braille characters, sends the braille characters to the slave, and performs audio feedback. The slave will receive the braille characters from the master and display, store, and actuate the intended braille on the display. It will also continuously send interrupts to the master to notify where the user’s finger is positioned. *Figure 6*, below, illustrates the product in its offboard and onboard configurations.

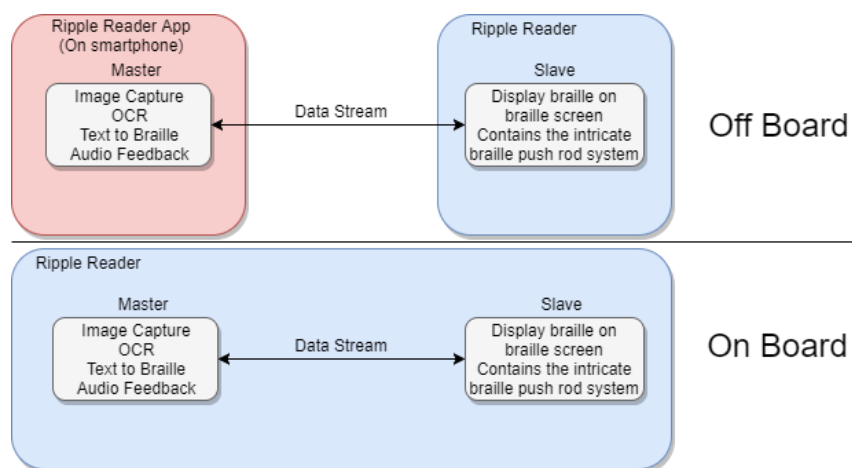

Figure 6 Naming conventions for board configurations

3.2 Classification

Each requirement of the Ripple Reader product is written as follows with explanations of sections and configurations listed in *Table 1* and *Table 2*

R[Section number].[Subsection number]{Configuration}

Section Number	
Functional	1
General	2
Software	3
Hardware	4
Mechanical	5
Electrical	6
Environmental	7
Safety	8

Table 1 Section numbers pertaining to requirements

Configuration	
Off-board	Off
On-board	On
Both	Both

Table 2 Configurations listed for each requirement

4. Requirements

4.1 Functional Requirements

Requirements in *Table 3* are set in order for the device to provide all its primary functionalities to the user. R1.1 is essential for us to demonstrate what we wish to accomplish in the spring months. It will be something we can showcase our ideas for for funding as well. R1.2 and R1.5 is meant to conserve power. R1.3 is a requirement meant to give the user a better experience with the device. R1.4 is set in place so the user can get the same experience as a regular braille reader. Because of our method of actuating cells, it is critical the user doesn't notice the cells are actuated any differently from a regular braille reader. R1.6, R1.7, and R1.8 ensure the user can have the educational feedback tailored to their own needs. R1.9, R1.10, R1.11, and R1.12 are enforced to ensure OCR and USB file upload to the Ripple Reader may be done. R1.13 is designed for the visually impaired as they would not typically be able to know otherwise if the battery was low. R1.14 provides a backup for relaying information from R1.13 or other messages in case the user is also deaf. R1.15 is meant to ensure that once a new file is uploaded, the reader is set to the beginning of the file, rather than some other inconvenient place. R1.16 and R1.17 are critical for allowing the user to navigate through documents beyond the 18 characters on the braille array. R1.18 is simply a user-notifying failure catch. When the product fails, we want the user to know what happened, so they can get the appropriate help. R1.19 is meant to ensure the user that while audio playback and other things may happen, if the device is not in off mode they can always read braille from the reader, even if other processes are running. Finally R1.20 gives users a way of erasing his files should he need privacy over the file they are reading.

Requirement ID	Design Stage	Description
R1.1{Both}	POC	The Ripple Reader shall use 54 LED lights to display the prototype implementation of the multiplexed actuators for 9 braille cells
R1.2{Both}	PRD/PRT	The slave shall have a power button to move it from Off mode to actuation mode and vice-versa
R1.3{Both}	PRD	The slave shall have persistent memory which lasts for at least 3 months while the device is off
R1.4{Both}	PRD/PRT	While in actuation mode, the slave shall activate the previous, current, and next characters of the braille array before the user's finger contacts it
R1.5{Both}	PRD/PRT	The slave shall depress all characters when the users finger is not over any characters
R1.6{Both}	PRD/PRT	The slave shall have a tristate audio configuration toggle to specify whether the user wants characters, words, or nothing to be read back to them
R1.7{Both}	PRD/PRT	The master shall read a character or word if a user places their finger on it for 1 second and it is currently configured for it
R1.8{Both}	PRD/PRT	The master will indicate unknown letters or words found by reading an error message to the user
R1.9{Both}	PRD/PRT/POC	The master shall perform OCR on any picture it takes
R1.10{Both}	PRD/PRT	The slave shall have a configuration toggle for a user to specify whether they want text translated to primary or advanced (AKA: contracted or advanced) braille

Requirement ID	Design Stage	Description
R1.11{Both}	PRD/PRT	The slave shall translate any text from the language of its specific user manual to either grade 2 or primary braille depending on the user configuration
R1.12{Both}	PRD/PRT	The master shall read an error message if the device is unintentionally set to the data capture mode
R1.13{Both}	PRD/PRT	The master shall give an audio message to the user when its battery is low
R1.14{Both}	PRD	The slave shall contain an error cell which may be read indicating low battery, and state errors
R1.15{Both}	PRD/PRT/POC	The slave shall index any translated text and set itself to read the first letters thereafter
R1.16{Both}	PRT/POC	The slave shall have a next button that will show as many of the next 9 characters that are available in the braille file
	PRD	The slave shall have a next button that will show as many of the next 18 characters that are available in the braille file
R1.17{Both}	PRT/POC	The slave shall have a previous button that will show as many of the next 9 characters that are available in the braille file
	PRD	The slave shall have a previous button that will show as many of the next 18 characters that are available in the braille file
R1.18{Both}	PRD/PRT	The slave shall produce an error if it enters scroll mode without pressing the up or down button
R1.19{Both}	PRD/PRT	The slave shall always be in either the Off or Actuation state and run any other necessary state's in parallel
R1.20{Both}	PRD	The Ripple Reader will have a soft-reset button to completely reset the braille cells and erase any temporarily stored files.

Table 3 Functional Requirements

4.2 General Requirements

The requirements in *Table 4* are necessary to make the user experience with the product as enjoyable as possible. R2.1, R2.2, R2.3, and R2.5 ensure the user will be able to use the Ripple Reader effectively. R2.4 is a requirement to make the device affordable. R2.6 and R2.7 are requirements necessary for optimal user experience. They are precise in nature and therefore were excluded from the functional requirement section.

Requirement ID	Design Stage	Description
R2.1{Both}	POC	The Ripple Reader shall be packaged with a user manual in English
	PRT	The Ripple Reader shall be packaged with a user manual in braille and English
	PRD	The Ripple Reader shall be packaged with a user manual in braille and at least one of English, Chinese, French, or Russian depending on the seller's location
R2.2{Both}	PRT/POC	All text and labels on the slave shall be written in the same languages given for the user manuals

Requirement ID	Design Stage	Description
R2.3{Off}	POC	Application UI shall be simple and intuitive for visually impaired. Must score 60/100 in usability [5]
R2.3{Off}	PRD/PRT	Application UI is simple and intuitive for visually impaired. Must score 80/100 in usability [5]
R2.4{Both}	PRD	The Ripple Reader will cost no more than \$200
R2.5{Both}	PRT/PRD	Each button on the slave shall have an embossed braille letter on top of it to give the user an additional sense of where things are
R2.6{Both}	PRD/PRT	Delay between files and actuation of those new characters will be a max of 1s
R2.7{Both}	PRD/PRT	Delay between change in finger position on Braille character and actuation of new characters adjacent to the finger (Feedback Response Time) is 0.02s

Table 4 General Requirements

4.3 Software Requirements

The requirements in *Table 5* ensure that the software being developed for the Ripple Reader follows some decided upon technologies and algorithms. R3.1, R3.4, and R3.5 are used for consistency of data input. R3.2, R3.6, and R3.7 gives a standard the OCR must meet for the user. R3.3 and R3.15 ensure data is sent and received quickly helping to give the user a seamless experience with our product. R3.8 gives the user confidence in the source of text scanned for English words. R3.9 is to ensure the camera can work in dark environments. R3.10 and R3.11 considers most of our audience and thus gives physical feedback to the user when actions have been completed as opposed to visual feedback. R3.12 is used for letting the user catch a failure. R3.13 and R3.14 are meant to respect the user. We believe a respected user is a happy user. Finally, R3.16 specifies which phones are compatible to work with the Ripple Reader.

Requirement ID	Design Stage	Description
R3.1{Both}	PRD/PRT	Images supported shall be in the correct PNG format [6]
R3.2{Both}	PRD/PRT	The desired font size of the text read from a camera is above 50 pixels in height for each corresponding letter
R3.3{Both}	PRD/PRT/PO C	Data collection shall be done in Real-Time (>60FPS)
R3.4{Both}	PRD/PRT	6-bit characters shall be transferred to the actuation processor
R3.5{Both}	PRD/PRT/PO C	Data read above 0.1V will be considered a logical one or else it shall be considered a logical 0
R3.6{Both}	PRD/PRT/PO C	Character recognition shall be performed in 0.1 seconds after identifying text
R3.7{Both}	PRD/PRT	Software shall accurately identify 99% of 50-pixel large Times New Roman characters oriented upright extracted with less than 11,000 lux when auto-flash is on
R3.8{Both}	PRD/PRT	Audio playback will accurately playback any braille letter or word supported by the Oxford 2017 dictionary
R3.9{On}	PRD/PRT	The master will have a flash that will be used to adjust the exposure of text being captured whenever the detected luminescence falls below 100lux

Requirement ID	Design Stage	Description
R3.10{Off}	PRD/PRT	The master will vibrate 3 times (0.1 second pulses) if the picture taken is focused correctly
R3.11{Off}	PRD/PRT	The master will vibrate 2 times (0.3 second pulses) if the picture is out of focus and needs to be taken again
R3.12{On}	PRD/PRT	The master will tell the user when an image cannot be read properly using an error audio cue
R3.13{Off}	PRD/PRT	Software will never send the user advertisements
R3.14{Off}	PRD/PRT	Software will never sell a users data without express consent
R3.15{Both}	PRD/PRT/POC	The location above the braille array shall be polled every 0.01 seconds for IR sensor data
R3.16{Off}	PRT	The Ripple Reader Application requires phones to be Android v4.4 (KitKat) or greater
	PRD	The Ripple Reader shall run on iOS and Android devices brought to the market after 2016

Table 5 Software Requirements

4.4 Hardware Requirements

The requirements in Table 6 will help Lamplight labs decide which hardware components to be purchased. R4.1, R4.2, R4.11 and R4.3 ensure we pick the correct components for our onboard solution. R4.4, R4.5, R4.6 standardizes the I/O that will be required for the Ripple Reader. R4.7 and R4.8 ensure the onboard solution has decent audio fidelity. Finally R4.9, R4.10, R4.12, are general physical attributes that will help in user ergonomics and include some user comforts.

Requirement ID	Design Stage	Description
R4.1{On}	PRT	The master's camera will be at least 8MP to ensure that the system will have a high enough resolution image for reliable OCR
R4.2{On}	PRT	The camera shall operate between -10 and 45 °Celsius
R4.3{Both}	PRT	The camera will autofocus the object being pointed to within 2 seconds after pointing at it
R4.4{Both}	PRD/PRT	The slave shall have a USB slot capable of transferring data following standards listed in this document [7] [8]
R4.5-{On}	PRD/PRT/POC	The slave shall contain a Bluetooth receiver capable of Bluetooth 4.0 communication conforming to standards listed in this document [9]
R4.6{Both}	PRD	The slave will either have a power charging port or will charge via an inductive charging plate
R4.7{On}	PRD/PRT	A volume adjustment dial will exist to allow the user to raise or lower the volume of the audio feedback
R4.8-{On}	PRD	The slave shall have a set of speakers with support for 20 to 60 decibel audio signals
R4.9{Both}	PRD	The slave will, not weigh more than 2.5kg
R4.10{Both}	PRD	The slave will be water-resistant
R4.11{Both}	PRT	The slave will work under 60% humidity levels
R4.12{Both}	PRT	The slave will be inside a 15cm x 10cm x 10cm box (+-0.5cm for each side)

Table 6 Hardware Requirements

4.5 Mechanical Requirements

The requirements in *Table 7* will help determine how much raw material will be required to build the Ripple Reader including helping to price it out. R5.1, R5.2, and R5.9 ensures the user has a good experience using our device. R5.3, R5.4, R5.5, and R5.6 pertain to the physical makeup of the product we are making. R5.7 is similar and provides a standard for the actuators to run at. R5.8 specifies an operating condition of our product. Finally, R5.10 gives the user the ability to take our product apart should it break and fix it.

Requirement ID	Design Stage	Description
R5.1{Both}	PRD/PRT	All braille dimensions shall conform to the standards specified in the document [10] [11] [12] [13] [14]
R5.2{Both}	PRD	The Ripple Reader shall have 2 rows of 9 braille characters each
	PRT/POC	The Ripple Reader shall have 1 row of 9 braille characters
R5.3{Both}	PRD/PRT	There shall be an IR sensor on each row of braille
R5.4{Both}	PRD/PRT	The slave shall use 18 actuators to actuate characters near the user's finger
R5.5{Both}	PRD/PRT	The slave shall contain horizontal rods spreading the force of each actuator to multiple dots
R5.6{Both}	PRD/PRT	The slave shall contain vertical rods to give actuation to each individual dot
R5.7{Both}	PRD/PRT	The slave shall contain a processor to direct the actuators that run at a frequency of least 5kHz
R5.8{Both}	PRD/PRT	The slave shall operate between -5 and 30 degrees Celsius
R5.9{Both}	PRT/PRD	All components of The slave must be fully functional within 5 seconds of setting the power toggle to on
R5.10{Both}	PRD	All parts will have a unique identification code

Table 7 Mechanical Requirements

4.6 Electrical Requirements

The requirements shown in *Table 8* are important to understand the Ripple Reader's circuits. R6.1, R6.2, R6.3, R6.7, and R6.8 will help optimize the devices battery life. R6.4 will help define the standards that our electric parts will adhere to. R6.5 and R6.6 are useful when determining the battery size. R6.9 and R6.10 define the methods of charging that a Production variant would contain. R6.11 is important to tell the type of power we will use.

Requirement ID	Design Stage	Description
R6.1{On}	PRT	The camera and flash will allow the User to take up to 100 photos and translate to braille before depleting entirely.
R6.2{Both}	PRT	The actuators being used will draw 50 Volts at full draw consuming 0.5 Watts of power
R6.3{Both}	PRD	The slave processor shall be powered by 3.3 volts
R6.4{Both}	PRD/PRT	The Ripple Reader shall conform to electrical standards [15] [16] [17] [18] [19]

Requirement ID	Design Stage	Description
R6.5{Both}	PRT/PRD	The slave will have at least a 2-hour active battery life
R6.6{Both}	PRD	The slave will have at least a 15-hour passive battery life (the device is on, but the actuators aren't stimulated)
R6.7{Both}	PRD	slave will enter a low power state after 5 minutes of inactivity
R6.8{Both}	PRT/PRD	slave will turn its off after 10 minutes of inactivity
R6.9{Both}	PRD	slave will have an external charging block or inductive charging plate
R6.10{Both}	PRD	The slave will, be able to charge off a typical external smartphone power pack. Note: Any performance loss from using a 3 rd party charging options isn't covered by LampLight Labs or it affiliated organizations.
R6.11{Both}	PRD/PRT	The Ripple Reader will be powered by DC power

Table 8 Electrical Requirements

4.7 Sustainability Requirements

Sustainability requirements in *Table 9* are essential for us here at LampLight Labs so we can guarantee our customer a long-lasting product, along with ensuring when our device is done being used, it can be recycled and reused to minimise the waste created. R7.1 is designed to keep the device safe. With all actuators set in when in the off state, nothing can get hooked to the actuator and break the device prematurely. R7.2 allows us engineers to perform updates in a simpler fashion. R7.3 allows the user to get external help. If a problem arises not mentioned in our user manual, this provides us a way of communicating with the customer to remedy the problem. R7.4 allows the product to be reused in a simpler way should part of the product fail. An onboard processor for instance could be switched for a Bluetooth module and an offboard processor if the onboard processor breaks allowing the rest of the product to still be used with a phone. R7.5, and R7.9 gives the user comfort in the material integrity of the product. R7.6, R7.7, and R7.8 makes sure that all materials used to create the product are eco-friendly and renewable. R7.10 and R7.11 both allow the user to fix the device or get someone else to fix the device.

Requirement ID	Design Stage	Description
R7.1{Both}	PRD/PRT	While in off mode, the slave shall depress all actuators
R7.2{Both}	PRD/PRT	Coding standards shall be enforced for all code written in the project following the standards listed [20] [21] [22] [23]
R7.3{Both}	PRD	On Phone Technical support shall be available to the end user if he encounters a problem
R7.4{Both}	PRD	Each part of the product shall be modular, allowing individual components to be fixed or replaced
R7.5{Both}	PRD	The Ripple Reader shall withstand a drop of over 1m from a concrete floor
R7.6{Both}	PRT/PRD	The Ripple Reader shall conform to all ISO/CSA/ANSI standards including but not limited to CSA 22.1 [24]
R7.7{Both}	PRD/PRT	The Ripple Reader shall be created entirely from recyclable or reusable material
R7.8{Both}	PRT	The body of the Ripple Reader shall be made of PLA plastic

Requirement ID	Design Stage	Description
R7.9{Both}	PRD	Sensors for the Ripple Reader shall be protected by a protective plastic shield
R7.10{Both}	PRD	Internal mechanisms and layout will be non-proprietary
R7.11{Both}	PRD	Repair manuals shall be created in the same languages as the user-manual is in

Table 9 Sustainability Requirements

4.8 Safety Requirements

We at Lamp Light Labs value the safety of our customer. As our primary users are visually impaired, they may be more susceptible to the potential risks present with electrical components and misuse of the device. The requirements mentioned in *Table 10* protect the user from being endangered by the Ripple Reader. R8.1 ensures that the material sourced for the creation of the Ripple Reader are from trusted manufacturers with a history of great quality control. R8.2 will make sure that the Ripple Reader is not unethical and is safe to use. R8.3, R8.4, R8.5, R8.6 and R8.7 help prevent the user from injuring themselves when using the Ripple Reader. Finally R8.8 will ensure no hazardous substances will be used for the device (Lead, Mercury, Cadmium, etc.) along with aid our device in being more environmentally friendly.

Requirement ID	Design Stage	Description
R8.1{Both}	PRD	Materials shall be received by respected manufacturers
R8.2{Both}	PRD	The manufacturers of the Ripple Reader shall abide by the Medical Device Regulations of Canada pertaining to the Manufacturer's Obligations [25]
R8.3{Both}	PRD	The Ripple Reader shall contain a low current fuse from its master energy source
R8.4{Both}	PRD/PRT	The Ripple Reader will disable the flash if it heats up beyond 45 degrees Celsius
R8.5{Both}	PRD/PRT	All electrical components shall be enclosed within the device
R8.6{Both}	PRD	The Ripple Reader will be marked with emblem to indicate that it passed its respective quality control tests.
R8.7{Both}	PRD/PRT	The corners of the all rods shall be rounded
R8.8{Both}	PRD/PRT	The electronics of the circuit shall comply with the RoHS guidelines [17]

Table 10 Safety Requirements

5. Related Engineering Standards and Guidelines

Our engineering team has collected of standards and guidelines to act as technical backbones of our requirements to guarantee our product will meet our clients' needs and to ensure our clients minimize any damage that can be done from ill use of the device. By taking into consideration the standards outlined below and following the referenced guidelines when appropriate during the Ripple Reader's prototype development, our product will already be well on the way to complete certification upon entering the final optimization phase before full commercial production.

5.1 Braille

By far the most important standards that the Ripple Reader must meet are those directly related to printing, manufacturing, and device replication of the braille language. Not surprisingly, the standards listed below in *Table 11* are not mere suggestions but hard facts that must be strictly adhered to during the entire development process. Failing to do so could jeopardize the commercial viability of the product because if a braille user does not recognize the Ripple Reader's refreshable braille cells or labelling then our product is of little use to them.

Standard Code	Standard Name	Issuer
N/A	Braille Formats: Principles of Print-to-Braille Transcription, 2016 [10]	Braille Authority of North America
N/A	Guidelines and Standards for Tactile Graphics, 2010 [11]	Braille Authority of North American & Canadian Braille Authority
N/A	Guidelines for the Production of Automated Braille Transaction Documents. 2016 [14]	Braille Literacy Canada
N/A	Rules of Unified English Braille, Second Edition, 2013 [13]	International Council on English Braille (ICEB)
N/A	Accessible Signage Guidelines, 2016 [12]	Braille Literacy Canada

Table 11 Braille Standards

5.2 Broadcasted Signals & Data Types

There are numerous standards that could have gone here but the four selected below in *Table 12* were crucial in building our final implementation of the Ripple Reader. The first three are related to the external communication, charging of the device. The final standard has been chosen as the image file type that the Ripple Reader will utilise during its image capture, manipulation, and processing stage and must be maintained throughout to prevent data corruption.

Standard Code	Standard Name	Issuer
N/A	Bluetooth Core Version 4.0 [9]	Bluetooth Special Interest Group
N/A	Universal Serial Bus Revision 2.0 Specifications [7]	Universal Serial Bus
N/A	Universal Serial Bus 3.2 Specifications [8]	Universal Serial Bus
ISO/IEC 15948:2003 (E)	Portable Network Graphics (PNG): Functional Specification [6]	International Standards Office

Table 12 Broadcasted Signals & Data Types

5.3 Printed Circuit Board & Electronics

Furthermore, the Ripple Reader will utilize a wide variety of power electronics, control boards, and processors to enable the desired end result outlined in the previous sections. Thus, LampLight Labs has selected specific health and safety standards, as seen below in *Table 13*, for our initial geographical market (that being Canada). As well as the Qi low power specification's for inductive charging since Qi version 1.4 supports 15W charging capability.

Finally, our engineering team will follow recognized national codes and safety regulations to guarantee that our product not only meets our client's demands but does so safely and efficiently.

Standard Code	Standard Name	Issuer
N/A	PCB Guidelines for Reduced EMI [19]	Texas Instruments
N/A	Qi low power specifications V1.4 [18]	Wireless Power Consortium
CAN/CSA-C22.2 NO. 61508-1:17	Functional safety of electrical/electronic/programmable electronic safety-related systems [15]	CSA Group
CAN/CSA-C22.2 NO. 0-10 (R2015)	General requirements - Canadian electrical code, part II [16]	CSA Group
N/A	Restriction of Hazardous devices directive [17]	RoHS

Table 13 PCB & Electronics

5.4 Software

For maintenance and clarity while building the Ripple Reader, we have opted to follow strict coding standards, *Table 14*, during the development of the product for smoother development as we integrate components along with previously mentioned reasons.

Standard Code	Standard Name	Issuer
N/A	Making the best use of C [26]	GNU
N/A	Style Guide for Python [20]	PEP 8
N/A	Code Conventions for Java [22]	Oracle
N/A	Branching Standards [23]	Digital JHelms

Table 14 Software Standards

5.5 Other

Other standards followed are shown in *Table 15* below to provide the user a safe and easy to use product which is also environmentally friendly.

Standard Code	Standard Name	Issue
N/A	Usability Score [5]	N/A
N/A	Medical Device Regulations [25]	March 2017
N/A	ANSI [24]	N/A

Table 15 Other Standards

6. Cradle to Cradle Lifecycle

Sustainability is the ability to meet our own needs without compromising the future generation's ability to meet their needs [27]. At LampLight labs we hope to achieve our sustainability goals by employing a hybrid of the reduce, reuse and recycle process and by employing the cradle to cradle design methodology.

The reduce reuse recycle methodology is based on utilizing designs that are functional yet sparing, using recycled components, and recycling the product once it reaches the end of its lifecycle. This approach slows down the wastage of resources but does not completely prevent it [21].

Unlike the reduce, reuse recycle process, the cradle to cradle design process aims to achieve zero waste. This is through combining renewable power sources, production using biodegradable and harmless components and reentering waste components as a resource into the production process [21].

Figure 7 **Error! Reference source not found.** below shows how these methodologies will be combined in our production process and the subsequent subtopics will discuss the different approaches to achieving sustainability goals.

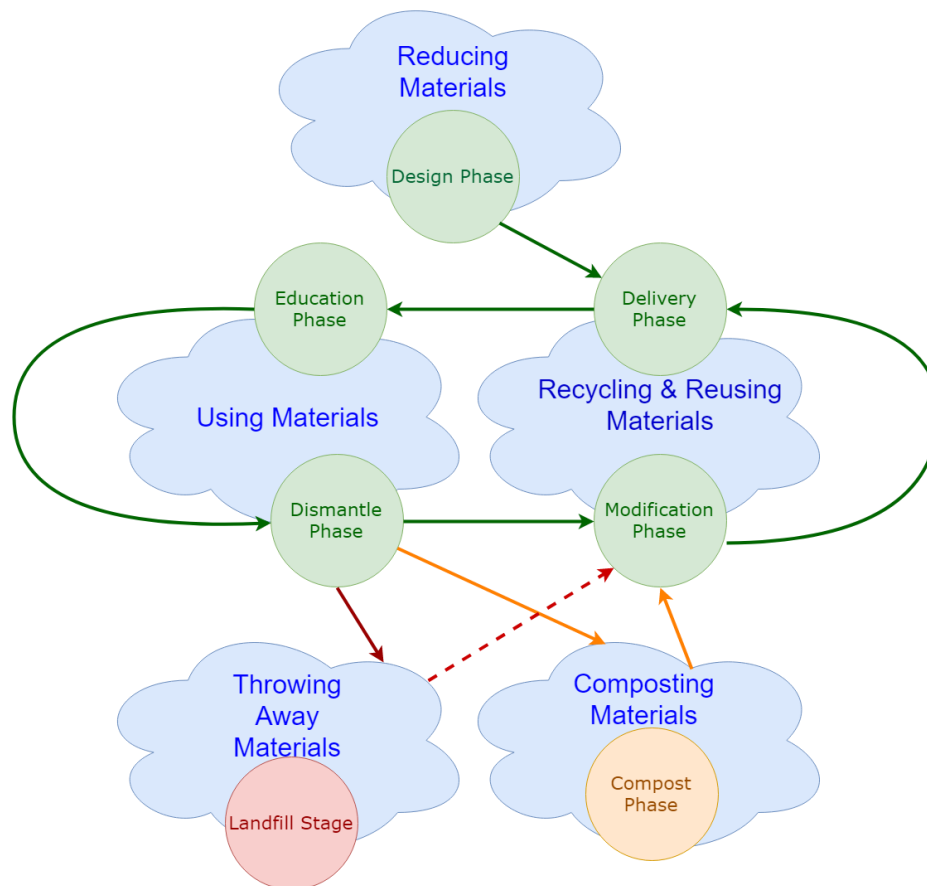

Figure 7 Model of the Ripple Readers Lifecycle

6.1 Selecting Materials

Priority will be given to material which is either recyclable, biodegradable or compostable when building the Ripple Reader. Most components are to be 3D printed using PLA, which is recyclable and biodegradable, as it is made from renewable materials such as corn starch [28]. We cannot forgo 3D printing as the parts that we require, such as the refreshable braille characters, require very accurate manufacturing. As this is a novel project we are unable to reuse such components either, as they are not readily available.

Components such as actuators, cameras, wiring, switches, nuts and bolts can be acquired in the recycled state. However, these components must be evaluated to ensure they abide by specific requirements and specific standards. The only concern in this instance is that recycled components do not have lifespans comparable to brand new components as certain wear and tear, such as material fatigue, cannot be fixed.

The PCBs employed for actuation and power supply are to be acquired from sources that specialize in printing such circuits. As these sources are limited, so are we when it comes to ensuring sustainability in the production process of the PCBs.

6.2 Recycling and Reusing Materials

The main body of the Ripple Reader, which will be 3D printed from PLA, is recyclable and biodegradable. PLA will also be utilized to make the actuation link network, and the braille characters, hence these components too are recyclable and reusable. We are also exploring the idea of using steel rods to build our actuation link network as steel is more rigid and durable than PLA. As steel is the most recyclable material in the world there would be no qualms whatsoever in utilizing steel for our device [29]. The camera, LED array and actuators can be reused, or recycled as they are not built for specification for the Ripple Reader. This also applies to the wiring, switches and fasteners. There are also services which recycle PCBs [30], hence a large portion of the Ripple Reader can either be reused or recycled.

6.3 Reducing Materials

At LampLight labs, one of our main goals is to make the Ripple Reader affordable to visually impaired people. One of our design decisions was limiting the number of actuators and using an actuation link network. This design thinking serves two purposes as it cuts down on cost and also helps reduce the number of required actuators from 108 to 18. Moreover, another one of our design decisions was to use offboard processing employing a smartphone. As such, a new processing platform need not be introduced as it is understood that users will possess at least the basic smartphone.

6.4 Disposing Materials

Any materials that do not fit in the above classifications can be disposed of by dismantling the Ripple Reader and unfastening these components from recyclable or biodegradable components. To suit such strategies, the Ripple Reader will employ non-permanent fastening methods such as threaded fastening. This way the Ripple Reader can be completely dismantled to prevent any contamination between components, which will hamper the recycling and reusing process.

7. Conclusion

Requirements provide a means to measure and design against user needs, after talking to people at the Canadian National Institute for the Blind who are visually impaired, we were able to discuss the needs and struggles they face. With the Ripple Reader, we are not only providing a temporary solution to those suffering from visual impairment but, ideally, a transformative device that will help inspire, encourage, and grow these individuals. LampLight Labs strongly believes everyone should have equal access to all forms of print media (digital or analogue) and have the freedom to expand their lives in whatever ways they deem fit.

We have compiled a list of all the general, hardware, software, mechanical, and electrical requirements we need for designing our braille device to meet the end user's needs. Our product is presented with three phases: A Proof-of-Concept phase, a Prototype phase and a Production phase. Each phase presents different requirements to meet the needs of our users'. With the use of material such as steel we aim to be environmentally conscious when the Ripple Reader reaches the end of its life cycle. Providing a safe device by controlling and protecting the heat and shock risks is a major topic we design against. Mechanically, we discussed the forces, spaces and structure our device will follow; while electrical requirements focus on power distribution.

This document will be used throughout the design and development process of the Ripple Reader to ensure that the device is safe, effective, reliable and resourceful. It provides an excellent means to verify our device, while we obtain validation from users.

References

- [1] "Brailleworks," [Online]. Available: <https://brailleworks.com/braille-literacy-statistics/>. [Accessed 15 02 2018].
- [2] "NFB," [Online]. Available: <https://nfb.org/braille-general>. [Accessed 14 02 2018].
- [3] R. Ryles, "NFB," [Online]. Available: <https://nfb.org/Images/nfb/Publications/bm/bm98/bm980204.htm>. [Accessed 28 01 2018].
- [4] "UNESCO," [Online]. Available: <http://data.uis.unesco.org>. [Accessed 19 02 2018].
- [5] "Usability Score," [Online]. Available: <https://www.usability.gov/how-to-and-tools/methods/system-usability-scale.html>. [Accessed 21 02 2018].
- [6] D. Duce, "PNG Specification," 10 11 2003. [Online]. Available: <https://www.w3.org/TR/2003/REC-PNG-20031110/>. [Accessed 20 02 2018].
- [7] "USB," [Online]. Available: http://www.usb.org/developers/docs/usb20_docs/. [Accessed 21 02 2018].
- [8] "USB," [Online]. Available: <http://www.usb.org/developers/docs/>. [Accessed 21 02 2018].
- [9] "Bluetooth," [Online]. Available: <https://www.bluetooth.com/specifications>. [Accessed 21 02 2018].
- [10] B. A. o. N. America, "Braille Authority of North America," [Online]. Available: <http://www.brailleauthority.org/formats/formats2016.html>. [Accessed 21 02 2018].
- [11] "Braille Authority of North America," [Online]. Available: <http://www.brailleauthority.org/tg/>. [Accessed 21 02 2018].
- [12] "Braille Literacy Canada," 2016. [Online]. Available: http://www.brailleliteracycanada.ca/CMFiles/Accessible_Signage_Guidelines_BLC-PrintFormatted.pdf. [Accessed 20 02 2018].
- [13] C. S. ICEB, "Rules of Unified English Braille Second Edition," [Online]. Available: <http://www.iceb.org/Rules%20of%20Unified%20English%20Braille%202013.pdf>. [Accessed 21 02 2018].
- [14] B. L. Canada, "Braille Literacy," [Online]. Available: <http://www.brailleliteracycanada.ca/CMFiles/GuidelinesForTransactionDocument.pdf>. [Accessed 21 02 2018].
- [15] CSA Group, "CAN/CSA-C22.2 NO. 61508-1:17 - Functional safety of electrical/electronic/programmable electronic safety-related systems - Part 1: General Requirements," CSA Group, Ottawa, 2017.
- [16] "Canadian Electrical Code," [Online]. Available: <http://shop.csa.ca/en/canada/electrical/canadian-electrical-code-part-ii-general-requirements/icat/cec2general>. [Accessed 21 02 2018].

- [17] "RoHS," 01 02 2018. [Online]. Available: <http://www.rohsguide.com/>. [Accessed 21 02 2018].
- [18] Wireless Power Consortium, "Qi low power specifications v1.4," Wireless Power Consortium, Piscataway, 2017.
- [19] Texas Instruments, "PCB Guidelines for Reduced EMI," Texas Instruments, Dallas, 1999.
- [20] B. W. N. C. Guido van Rossum, "Python," [Online]. Available: <https://www.python.org/dev/peps/pep-0008/>. [Accessed 21 02 2018].
- [21] "PopFlock," [Online]. Available: http://www.popflock.com/learn?s=Cradle_to_Cradle_Design. [Accessed 21 02 2018].
- [22] S. Microsystems, "Oracle," Sun Microsystems, 20 04 1999. [Online]. Available: <http://www.oracle.com/technetwork/java/codeconvtoc-136057.html>. [Accessed 21 02 2018].
- [23] D. JHelms, 2013. [Online]. Available: <https://gist.github.com/digitaljhelms/4287848>. [Accessed 21 02 2018].
- [24] "ANSI," [Online]. Available: https://webstore.ansi.org/?&source=google&keyword=ansi%20standards&gclid=EAlaIqobChMly7eKmKu52QIVDHd-Ch3hWQwUEAAYASAAEgIXEfD_BwE. [Accessed 21 02 2018].
- [25] "Medical Device Regulations of Canada," [Online]. Available: <https://www.emergogroup.com/sites/default/files/canada-medical-devices-regulations-sor-98-282.pdf>. [Accessed 21 02 2018].
- [26] Anonomous. [Online]. Available: https://www.gnu.org/prep/standards/html_node/Writing-C.html. [Accessed 21 02 2018].
- [27] "What is Sustainability," [Online]. Available: <https://www.mcgill.ca/sustainability/files/sustainability/what-is-sustainability.pdf>. [Accessed 21 02 2018].
- [28] M. Creighton, "Creative Mechanisms," [Online]. Available: <https://www.creativemechanisms.com/blog/learn-about-poly-lactic-acid-pla-prototypes>. [Accessed 21 02 2018].
- [29] "World Auto Steel," 2018. [Online]. Available: <http://www.worldautosteel.org/life-cycle-thinking/recycling/>. [Accessed 17 02 2018].
- [30] B. R. Inc, "B.W Recycling Inc," [Online]. Available: <http://www.webuyics.com/scrap-pcb.htm>. [Accessed 21 02 2018].

Appendix I

For the Proof on Concept, the device being demonstrated will be a mock-up of how the Prototype could possibly work. The POC will consist of two separate components; the first being the smartphone preloaded with the Ripple Reader App and the second being a grid of LEDs representing 9 braille characters connected to a microcontroller such as an Arduino or raspberry pi.

At the highest level, the user will open the Ripple Reader app on their phone, point the camera to some text, and wait for a specific vibration pattern signifying that the image recognition was successful. A message will be sent to a separate device which will be a grid array of LEDs controlled by a microcontroller representing the braille dots. A high level diagram depicting this is shown in *Figure 8*. Below in *Table 16* are the requirements that the POC will meet.

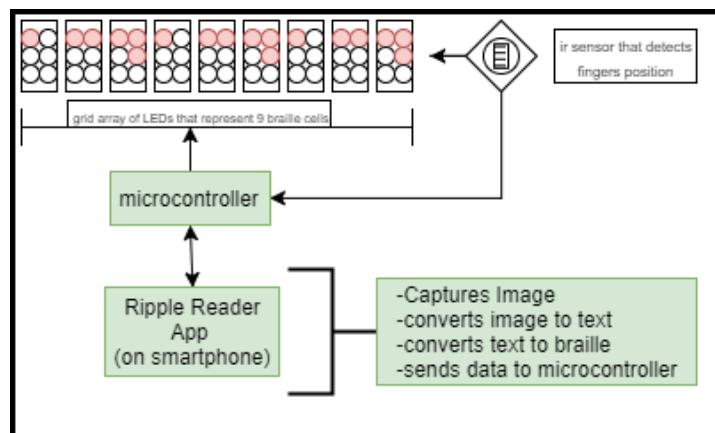

Figure 8 Proof of Concept Ripple Reader

POC Requirement ID	Description
P.1	The Ripple Reader shall use 54 LED lights to display the previous, current and next characters. This pattern will be replicated in the adjacent cells totaling 9 cells.
P.2	The Ripple Reader shall perform OCR on any picture of English text it takes
P.3	The Ripple Reader shall have a next button that will show the next 9 characters that are available in the braille file
P.4	The Ripple Reader shall have a previous button that will show the previous 9 characters that are available in the braille file
P.5	The Ripple Reader shall be packaged with a user manual in English
P.6	Application UI shall be simple and intuitive for visually impaired. Must score 60/100 in usability [5]
P.7	Data collection shall be done in Real-Time (>60FPS)
P.8	signals read above 0.1V will be considered a logical one or else it shall be considered a logical 0
P.9	Character recognition shall be performed in 0.1 second after identifying text
P.10	The location above the braille array shall be polled every 0.01 seconds for IR sensor data
P.11	The slave shall contain a Bluetooth receiver capable of Bluetooth 4.0 communication conforming to standards listed in this document [9]
P.12	Standard 6 dot Braille character will be used

Table 16 POC Requirements